

### APPLICATION

Separable elbow connector designed to connect polymeric insulated cable to equipment (transformers, switchgear, motors...).

### TECHNICAL CHARACTERISTICS

- A thick conductive EPDM jacket provides a total safe to touch screen.
- Each separable connector is tested for AC withstand and partial discharge prior to leaving the factory.



### DESIGN

Separable connector comprising:

1. Conductive EPDM insert.
2. Conductive EPDM jacket.
3. Insulating EPDM layer.
4. Type A interface as described by CENELEC EN 50180 and 50181.
5. Conductor contact.
6. Earthing lead.
7. Cable reducer.

The screen break design enables cable outer sheath testing without removing or dismantling the connector.

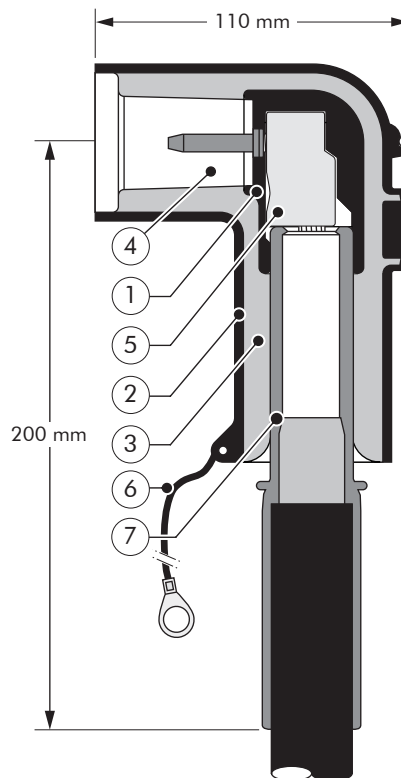

6/10 (12) kV  
6.35/11 (12) kV  
8.7/15 (17.5) kV  
12/20 (24) kV  
12.7/22 (24) kV

Up to 24 kV  
250 A

**EUROMOLD®**

### SPECIFICATIONS AND STANDARDS

The 200LR separable connector meets the requirements of CENELEC HD 629.1.

Separable connector type	Current I <sub>r</sub> (A)	Voltage U <sub>m</sub> (kV)	Conductor sizes (mm <sup>2</sup> )		Diameter over insulation (mm)	
			min	max	min	max
K200LR-12	250	12 17.5	25 25	95 50	13.0	21.0
K200LR-16	250	17.5 24	50 25	95 95	17.5	25.0

## KIT CONTENTS

The complete K200LR elbow connector kit comprises 3x the following components:

The kit also comprises silicone grease, water sealing mastic, gloves, wipers, adhesive tape and installation instructions.

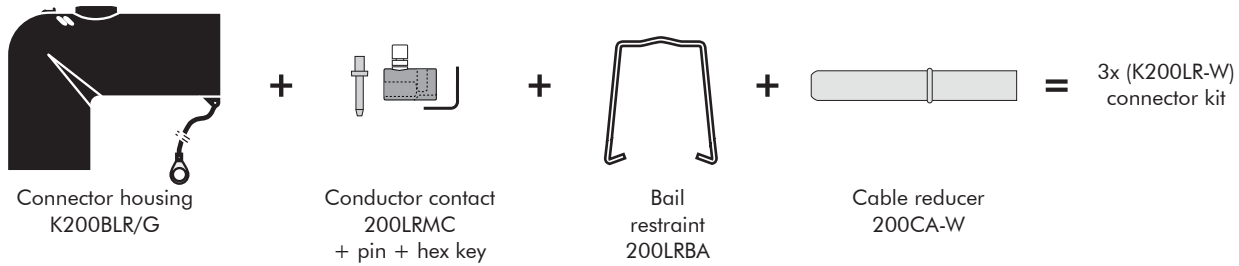

## ORDERING INSTRUCTIONS

To order a kit of 3 elbow connectors, specify the type:

- for 12 kV applications: 3x (K200LR-12).
- for 17.5 kV applications: 3x (K200LR-12) for 25 up to 50 mm<sup>2</sup>  
3x (K200LR-16) for 50 up to 95 mm<sup>2</sup>.
- for 24 kV applications: 3x (K200LR-16).

### EXAMPLE:

The cable is 24 kV, 50 mm<sup>2</sup> compact stranded aluminium with a diameter over core insulation of 20.5 mm and copper screen wires.

Order 3x (K200LR-16) elbow connector kit.

## OPTIONS

### VOLTAGE DETECTION POINT

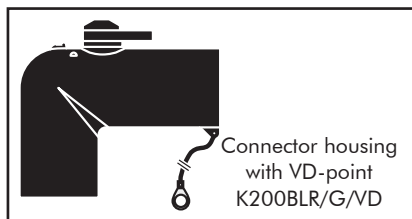

A version with a capacitive voltage divider for voltage detection is also available: add -VD to the specified type.

### LARGER CONDUCTOR SIZES

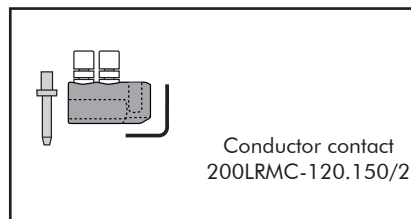

A version for larger conductor sizes (120 and 150 mm<sup>2</sup>) is also available.

Specify connector type	Current I <sub>r</sub> (A)	Voltage U <sub>m</sub> (kV)	Conductor sizes (mm <sup>2</sup> )	Diameter over insulation
3x (K200LR-16-120.150)	250	12	120-150	17.5-25.0
3x (K200LR-19-120.150)	250	17.5-24	120-150	21.5-28.5

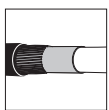

For use with copper wire screened cables. No earthing device is necessary.

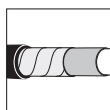

For use with copper tape screened cables. Add -CT to order.

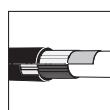

For use with Alupe or C 33-226 cables. Add -MT345 to order.



For use with other cable types. Please contact our representative.



All kits are suitable for use indoor and outdoor.



PEP eco passport available